

Honeywell

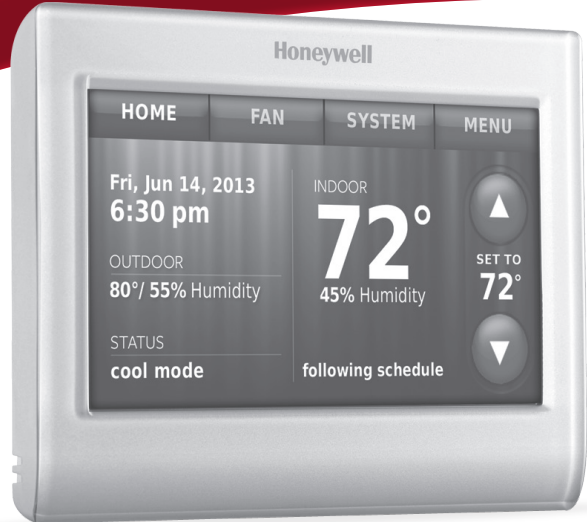

Quick Start Guide

Wi-Fi Color Touchscreen
Programmable Thermostat

RTH9590 Wi-Fi With Voice Control

Welcome

Getting set up and ready is simple.

- 1 Install your thermostat.
- 2 Connect your home Wi-Fi network.
- 3 Register online for remote access.

Before you begin



View the installation video at wifithermostat.com/support



You will need your camera to take a picture of your old wire connections.



You will also need:

- Small screw driver
- Pen
- Thermostat ID card
- Your home Wi-Fi network password

1 Install your thermostat

1.1 Switch OFF power to your heating/cooling system

1.1a **Important!** To protect your equipment, switch OFF the power to your heating/cooling system at the breaker box or the system switch.

1.1b Confirm power is OFF. Try to turn on heating/cooling equipment by changing temperature on your old thermostat. Your power is OFF if your system does not turn ON.

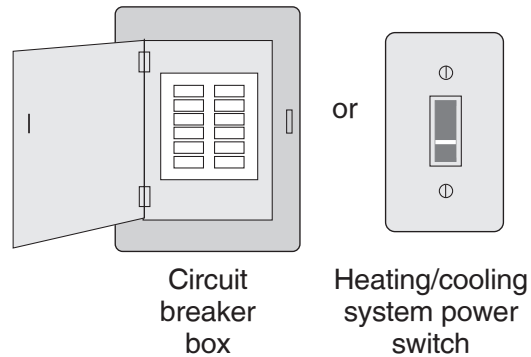

! *This thermostat works with common 24 volt systems such as forced air, hydronic, heat pump, oil, gas, and electric. It will not work with millivolt systems, such as a gas fireplace, or with 120/240 volt systems such as baseboard electric heat.*

1.2 Remove old thermostat faceplate and leave wires connected

 1.2a Take a picture of the wire connections for later reference.

 1.2b If no wire is connected to a terminal labeled C or no C terminal exists on the old thermostat, view the Alternate Wiring videos at wifithermostat.com/videos

Important! C wire is required and is the power source for your thermostat. Without a C wire, your thermostat will not power up.



Note: You will need a picture of your wire connections to wire the new thermostat.

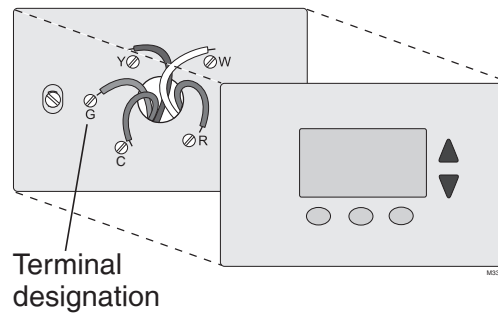

If you have an older thermostat with a sealed mercury tube, see warning page for proper disposal instructions.

1.3 Label wires

Do not label by wire color.

Use the supplied sticky tags to label each wire as you disconnect it. Label wires according to old thermostat terminal designations, not by wire color.

Note: If no tag matches a terminal designation, write the appropriate letter on a blank sticky tag.

Note: Wrap the wires around a pencil to prevent them from falling back into the wall.

1.4 Remove wallplate

Remove the old wallplate from the wall after all wires are labeled and disconnected.



Blank tags

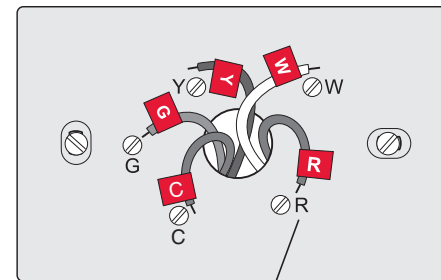

Terminal designation

1.5 Mount wallplate for Wi-Fi thermostat

Mount your new wallplate using screws and anchors included with the thermostat.

If necessary:

- Drill 3/16-in holes for drywall
- Drill 7/32-in holes for plaster

Note: You may be able to use your existing wall anchors. Hold the wallplate up to the existing anchors to check for alignment.

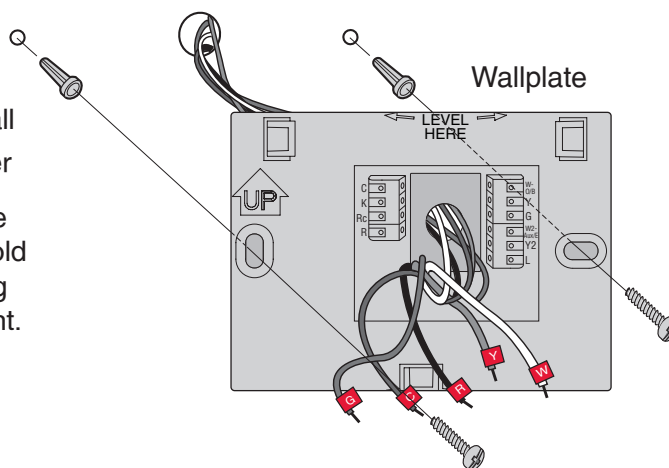

1.6 Connect wires

Important! C wire is required and is the power source. Without a C wire, your thermostat will not power up.

 View the Alternate Wiring videos at wifithermostat.com/videos

1.6a Starting with the C Wire, match the sticky tag on the wire to the terminal labels.

1.6b Straighten wire and gently slide into terminal hole until it clicks into place. (If you need to remove a wire, use a pen tip to press the terminal release and then pull the wire out.)

Note: Refer to the wiring picture you took in Step 1.2.

Tip: To make it easier to slide the wire into place, use a pen tip to hold down the terminal release.

Note: The wiring for your application might be different than the wiring shown below.

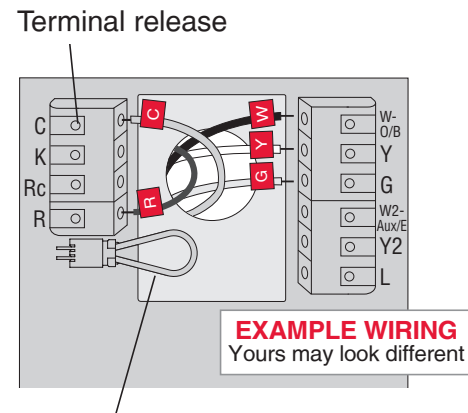

Remove jumper loop **ONLY** if you have both **R and Rc** wires.



Labels don't match or have heat pump system?

See *User Guide*.

- 1.6c In the image on the right, check the box next to each connection. You will use this checklist in Step 1.9.
- 1.6d Verify wire is firmly secured by gently pulling on wire.
- 1.6e Repeat steps a–d for all other wires.
- 1.6f Push any excess wire back into the wall opening after all wires are installed.

Note: The **L** terminal on the lower right is used only for Heat Pump systems.

Note: If the old thermostat for Heat Pump System has separate wires on **Aux** and **E**, use a wire nut to attach both wires to a separate wire. Slide this third wire into the **W2-Aux/E** terminal.

Important!



Check the box for each wire you connect. You will need this information in Step 1.9.

C	<input type="checkbox"/>	<input type="checkbox"/>	W-O/B
K	<input type="checkbox"/>	<input type="checkbox"/>	Y
Rc	<input type="checkbox"/>	<input type="checkbox"/>	G
R	<input type="checkbox"/>	<input type="checkbox"/>	W2-Aux/E
		<input type="checkbox"/>	Y2
		<input type="checkbox"/>	L



Labels don't match or have heat pump system?

See *User Guide*.

1.7 Attach thermostat to wallplate

Align the thermostat with wallplate and snap into place.

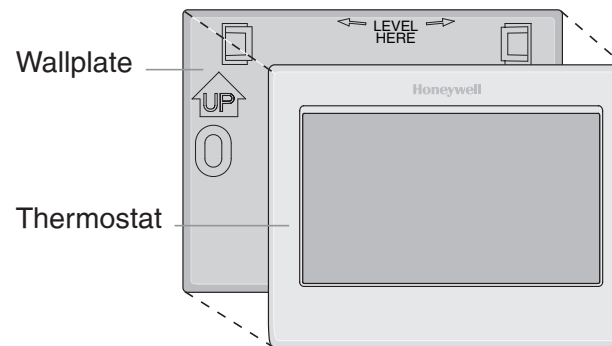

1.8 Switch heating/cooling system ON

Important!

- 1.8a Verify that the C wire is connected at the thermostat and at the heating/cooling system.
- 1.8b Make sure the heating/cooling system door is firmly secured.
- 1.8c Switch power back ON for your heating/cooling system at the breaker box or its power switch.

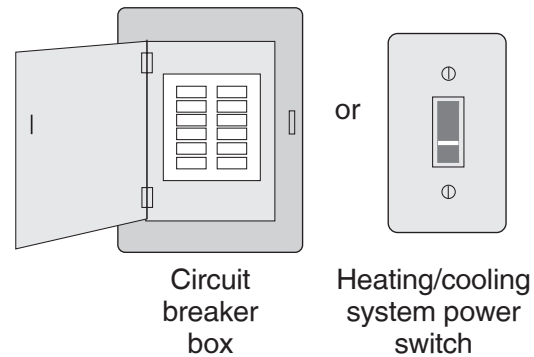

1.9 Select setup

Before connecting to your Wi-Fi network, you need to set initial thermostat options to define your heating/cooling system:

- Language
- Home or business

Follow prompts on the screen to select appropriate options.

1.9a Touch the language you want the thermostat to display, then touch **Next**.

1.9b Select Home or Business application, then touch **Next**.

1.9c Touch **Next** or name the thermostat location—touch THERMOSTAT and follow the rest of the instructions.

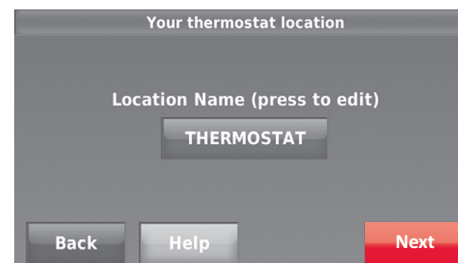
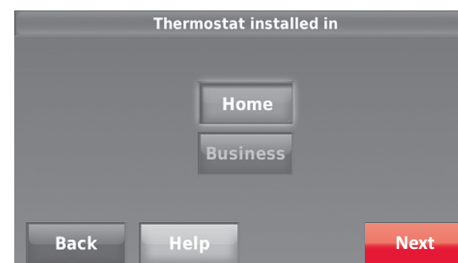

- 1.9d Select what your thermostat will control and touch **Next**.
- 1.9e Select your system type and touch **Next**. The system type determines other selection for completing initial setup. Use the checklist from Step 1.6 when making selections.
- 1.9f Touch **Next** after making selections on each screen.
- 1.9g Touch **Done** on the last screen. The thermostat displays an option to connect to your Wi-Fi network.

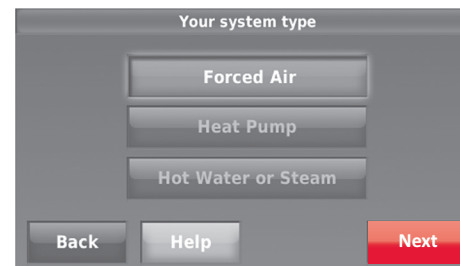
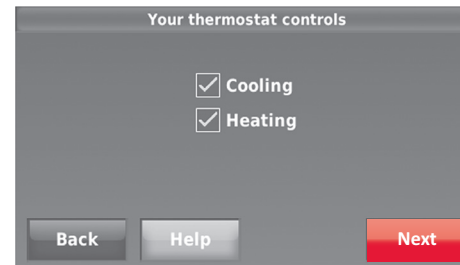

2 Connect to your Wi-Fi network

2.1 Connect the Wi-Fi network

After touching **Done** on the final screen of the initial set up (Step 1.9g), the thermostat displays an option to connect to your Wi-Fi network.

2.1a Touch **Yes** to connect the thermostat to your Wi-Fi network. The screen displays the message “Searching for wireless networks. Please wait...” after which it displays a list of all Wi-Fi networks it can find.

Note: If you cannot complete this step now, touch **I'll do it later**. The thermostat will display the home screen. Complete this process by selecting **MENU > Wi-Fi Setup**. Continue with Step 2.1b.



- 2.1b Touch the name of the network you want to use. The thermostat displays a password page.
- 2.1c Using the keyboard, touch the characters that spell out your home network password.
- 2.1d Touch **Done**. The thermostat displays “Connecting to your network. Please wait...” then shows a “Connection Successful” screen.

Note: If your home network is not shown on the list, touch **Rescan**.

- 2.1e Touch **Next** to display the registration information screen.

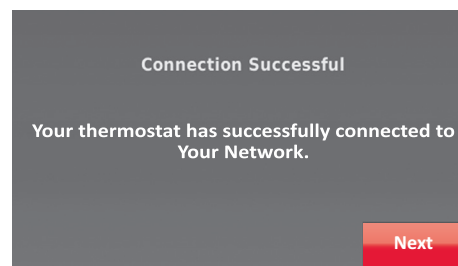
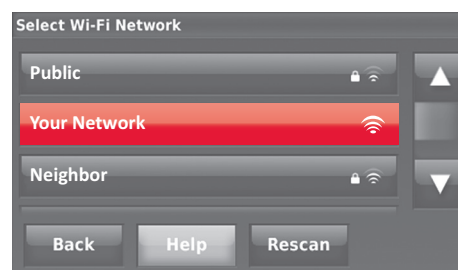

Getting Help

If you get stuck...

At any point in the Wi-Fi connection process, restart the thermostat by removing the thermostat from the wallplate, wait for 5 seconds, and snap it back into place. From the home screen, touch **MENU** > **Wi-Fi Setup** > **Choose a Network**. Continue with Step 2.1b.

Need more help?

Find additional information in the *User Guide*.



This thermostat works with common 24 volt systems such as forced air, hydronic, heat pump, oil, gas, and electric. It will not work with millivolt systems, such as a gas fireplace, or with 120/240 volt systems such as baseboard electric heat.



MERCURY NOTICE: Do not place your old thermostat in the trash if it contains mercury in a sealed tube. Contact the Thermostat Recycling Corporation at www.thermostat-recycle.org or 1-800-238-8192 for information on how and where to properly and safely dispose of your old thermostat.



NOTICE: To avoid possible compressor damage, do not run air conditioner if the outside temperature drops below 50°F (10°C).

3 Register online for remote access

To register your thermostat, follow the instructions on Step 3.1.

Note: The Register Online screen remains active until you complete registration and/or touch **Done**.

Note: If you touch **Done** before you register online, your home screen displays an orange alert button telling you to register. Touching that button displays registration information and an option to snooze the task.

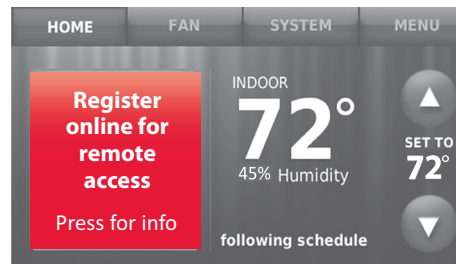
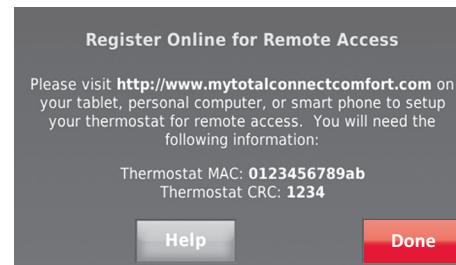

To view and set your Wi-Fi thermostat remotely, you must have a Total Connect Comfort account. Follow the instructions below.



View the Wi-Fi Thermostat Registration video at wifithermostat.com/videos

3.1 Open the Total Connect Comfort web site

Go to www.mytotalconnectcomfort.com



3.2 Login or create an account

If you have an account,
click **Login**

– or –

click **Create An Account**.

3.2a Follow the instructions on the
screen.

3.2b **Check your email** for a response
from My Total Connect Comfort.
This may take several minutes.

Note: If you do not receive a response,
check your junk mailbox or use an
alternate e-mail address.

3.2c **Follow activation instructions**
in the email.

3.2d Log in.

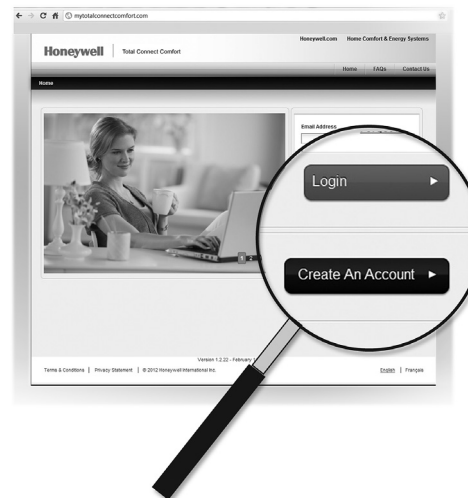

3.3 Register your Wi-Fi thermostat

After you are logged in to your Total Connect Comfort account, register your thermostat.

3.3a Follow the instructions on the screen. After adding your thermostat location you must enter your thermostat's unique identifiers:

- MAC ID
- MAC CRC

Note: These IDs are listed on the Thermostat ID Card included in the thermostat package. The IDs are not case sensitive.

3.3b Notice that when the thermostat is successfully registered, the Total Connect Comfort registration screen will display a SUCCESS message.

You can now control your thermostat from anywhere through your laptop, tablet, or smartphone.

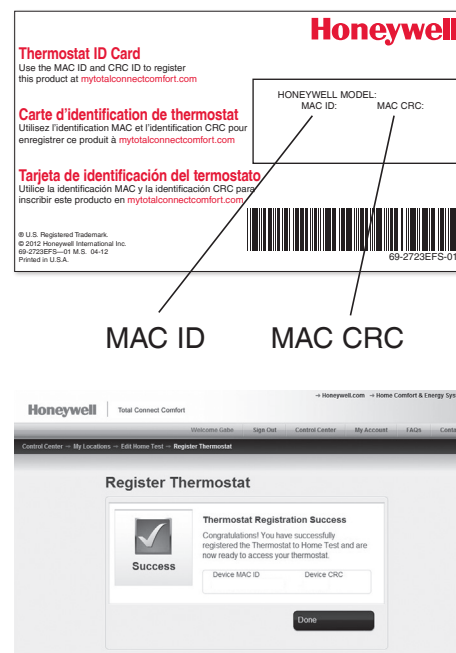

Getting started with voice

For information on how to control your thermostat with voice, see the included “Talking with your Thermostat” card.

Note that the voice commands for this thermostat are in English only.



Need help?

Visit wifithermostat.com or call 1-888-235-6569 for assistance before returning the thermostat to the store.



Total Connect Comfort free app is available for Apple® iPhone®, iPad® and iPod touch® devices at iTunes® or at Google Play® for all Android™ devices.



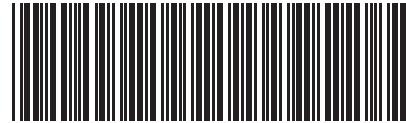

69-2791-03

Automation and Control Systems

Honeywell International Inc.

1985 Douglas Drive North

Golden Valley, MN 55422

wifithermostat.com

Honeywell

® U.S. Registered Trademark.

Apple, iPhone, iPad, iPod touch and iTunes are trademarks of Apple Inc.

All other trademarks are the property of their respective owners.

© 2013 Honeywell International Inc.

69-2791—03 M.S. Rev. 07-13

Printed in U.S.A.