



Model CT87 Installation Quick Guide

Items needed: Pan head screwdriver, drill and level.

1. Turn off Heating/Cooling system power.

 2. Remove old thermostat from wall. Use enclosed labels to mark the wires as you disconnect them. Label wires by using letters above screw terminals, not wire colors.

 3. Mount the cover ring (optional) and wallplate or subbase to the wall using a level.

4. Attach the system wires to matching screw terminals using the label designations from step 2.

 *Tip* Set the heat anticipator indicator to 1.2 before wiring the thermostat.

 5. Remove the thermostat cover and mount the thermostat to the wallplate or subbase.

6. Remove and discard the red plastic insert securing the mercury switch.

7. Set the heat anticipator indicator by matching the heat anticipator setting from your old thermostat or using the chart below.

Your Heating System	Anticipator Settings
Steam	1.2
Hot Water Heat	0.8
High Efficiency Hot Air	0.8
Standard Hot Air	0.4
Electric Heat	0.3

8. Attach the thermostat cover.

9. Set thermostat to desired temperature.

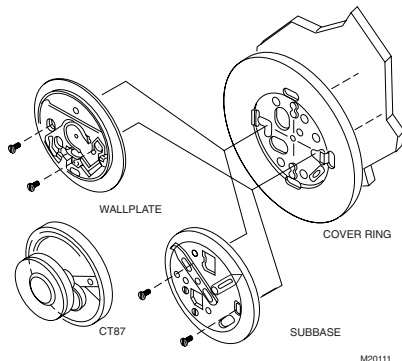

M20111

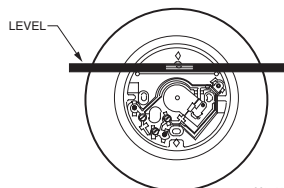

M20112

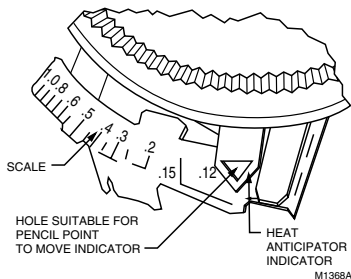

M1368A

Congratulations! You have finished installing your new Honeywell thermostat!
For additional information refer to Installation Instructions or contact Honeywell Customer Relations at www.honeywell.com/yourhome or 1-800-468-1502.

 Printed in U.S.A. on recycled paper containing at least 10% post-consumer paper fibers.

Copyright © 2005 Honeywell •  • All Rights Reserved



69-1552ES

Elementos necesarios: Destornillador de cabeza troncocónica, perforadora y nivel

1. Apague el sistema de Calefacción/Refrigeración.

 2. Quite el termostato viejo de la pared. Utilice las etiquetas incluidas para marcar los cables a medida que los vaya desconectando. Clasifique los cables utilizando las letras que se encuentran por encima de los terminales para tornillos, no por el color de los cables.

 3. Monte el aro protector (opcional) y la placa de pared o subbase en la pared utilizando un nivel.

4. Acople los cables del sistema a los terminales para tornillos según las designaciones de etiquetas mencionadas en el paso 2.

 **Ajuste el indicador del anticipador de calor a 1,2 antes de conectar el termostato.**

 5. Quite la cubierta del termostato y monte el termostato en la placa de pared o subbase.

6. Quite y deshágase del separador plástico de color rojo que asegura el interruptor de mercurio.

7. Ajuste el indicador del anticipador de calor haciendo que coincida el ajuste del anticipador de calor de su termostato viejo o bien utilizando el cuadro a continuación.

Su Sistema de Calefacción	Anticipador Ajustes
Vapor	1,2
Calefacción por agua caliente	0,8
Aire caliente de alta eficiencia	0,8
Aire caliente estándar	0,4
Calefacción eléctrica	0,3

8. Coloque la cubierta del termostato.

9. Ajuste el termostato a la temperatura deseada.

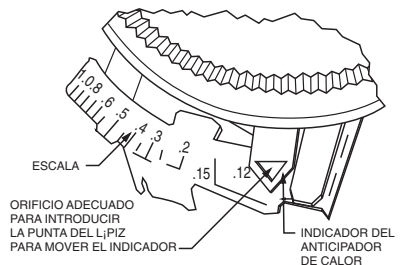
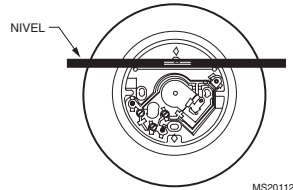
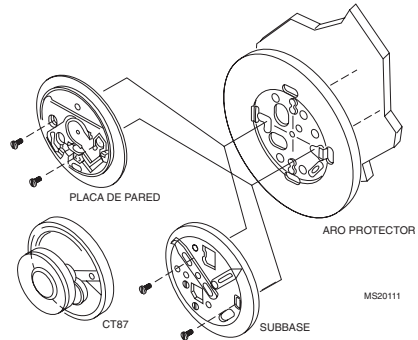

¡Felicitaciones! Ha terminado de instalar su nuevo termostato Honeywell! Para obtener información adicional, consulte la Instrucciones de Instalación o comuníquese con el departamento de Atención al Cliente en www.honeywell.com/yourhome o llamando al 1-800-468-1502.

 Impreso en E.U.A. en papel reciclado con un mínimo de 10% de fibras de papel postconsumidor.

Copyright © 2005 Honeywell •  • All Rights Reserved



69-1552ES